

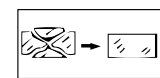

0201

INDUSTRIAL

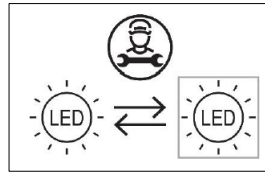
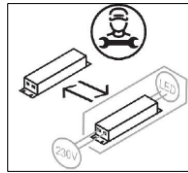

## AVVERTENZE

### SONO VIETATE MODIFICHE ALL'APPARECCHIO SENZA AUTORIZZAZIONE

Perseguiamo una politica di costante miglioramento del prodotto. Ci riserviamo il diritto di modificare le caratteristiche dell'apparecchiatura senza preavviso. Si prega di fare riferimento al sito [www.arcluce.it](http://www.arcluce.it) per questo e altri documenti tecnici che vengono continuamente aggiornati. Tutte le informazioni sono presentate in buona fede. Nessuna responsabilità ci può essere attribuita per errori, omissioni o interpretazioni errate. Le fotografie e i disegni sono nei limiti della qualità della riproduzione stampata, non sono vincolanti e solo per informazione.



Direttiva 2002/96/CE (Rifiuti di Apparecchiature Elettriche ed Elettroniche - RAEE). Il pittogramma del bidone con ruote barrato indica che questo prodotto non deve essere smaltito come normale rifiuto urbano ma attraverso raccolta separata; questo per evitare potenziali conseguenze negative per l'ambiente e la salute umana. Per i dettagli sulle strutture di raccolta disponibili, contattare l'ufficio governativo locale o il rivenditore presso il quale è stato acquistato il prodotto.

La sicurezza e il corretto funzionamento dell'apparecchio sono garantiti solo rispettando le normative elettriche e queste istruzioni pertanto è necessario conservarle. L'installazione deve essere eseguita da personale qualificato fare sempre riferimento ai dati elettrici presenti sull'etichetta dell'apparecchio. La sorgente luminosa contenuta in questo apparecchio deve essere sostituita solo dal costruttore o dal suo servizio di assistenza o da personale altrettanto qualificato. Utilizzare solamente pezzi di ricambio originali ARCLUCE.



Prima di qualsiasi intervento sul dispositivo, spegnere l'alimentazione.

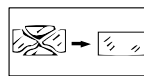

Sostituire gli schermi di protezione danneggiati.



Gruppo di rischio 1 (IEC/TR62778). L'apparecchio deve essere posizionato in modo da non causare sguardi prolungati nell'apparecchio a una distanza inferiore a 2m.

## WARNING

### ANY MODIFICATION TO THIS FITTING IS FORBIDDEN WITHOUT PRIOR AUTHORIZATION

Our policy is the constant improvement of the product. We reserve the right to modify the characteristics of the equipment without prior notice. Please refer to the website [www.arcluce.it](http://www.arcluce.it) for this and other technical documents continually updated.

All information is presented in good faith. no responsibility may be imputed to us for errors, omissions or incorrect interpretations.

The photographs and drawings are within the limits of the quality of the printed reproduction, not binding and indicative only.



Directive 2002/96/CE (Waste Electrical and Electronic Equipment - WEEE). The crossed out wheeled bin label that this product should not be disposed how the normal household waste stream, but with a separate collection; this in order to prevent potential negative consequences for the environment and the human health. For more details on available collection facilities please contact your local government office or the dealer where you purchased this product.

The safety and the proper functioning of the fitting is guaranteed only respecting the electrical Standards and this mounting instructions; therefore it's necessary to keep them.

Installation should be carried out by a suitable qualified person. Always refer to electrical data on the fixture label.

The light source contained in this luminaire shall only be replaced by the manufacturer or his service agent or a similar qualified person. Only use original ARCLUCE spare parts.



Turn off power before maintenance.

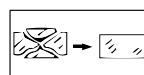

Replace any cracked shield.



Risk group 1 (IEC/TR62778). Do not stare at operating LED. The luminaire should be positioned so that prolonged staring into the luminaire at a distance closer than 2m is not expected.

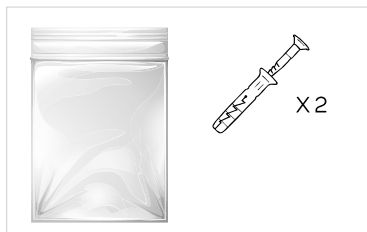
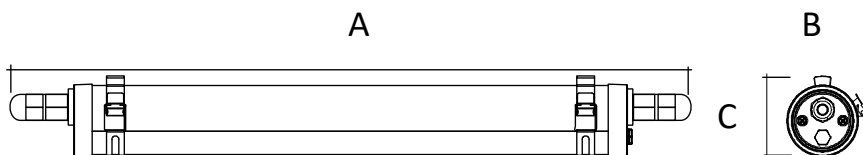

THERMA	
Dimensioni: <i>Dimensions:</i>	A: 1200 / 1500 mm B: 75 mm C: 75 mm
Peso: <i>Weight:</i>	1,8 / 2,3 Kg
T di funzionamento (T max) <i>Rated Ta (max Ta):</i>	-40°C ÷ +50°C
Cablaggio: <i>Wiring:</i>	ON/OFF, DIMM
Alimentazione: <i>Input:</i>	220-240V 50/60Hz

## INSTALLAZIONE - INSTALLATION

1

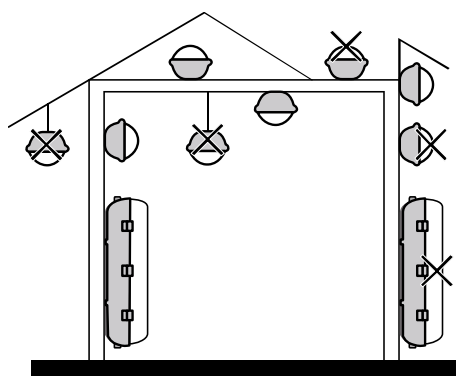

Non installare su superfici soggette a vibrazioni.  
*Do not install on surfaces subject to vibrations.*

2

LUNGH APPARECCHIO <i>FIXTURE LENGHT</i>	THERMA d
1200 mm	1135 mm
1500 mm	1435 mm

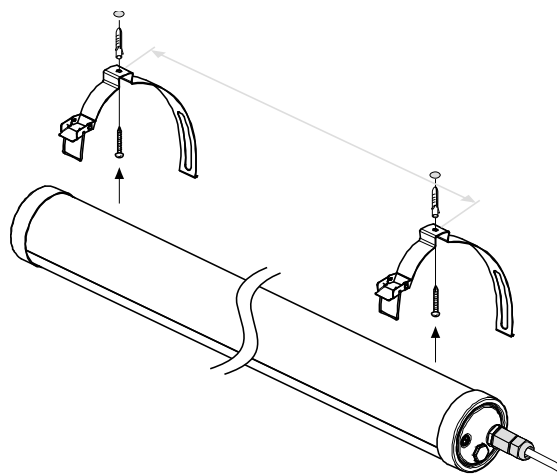
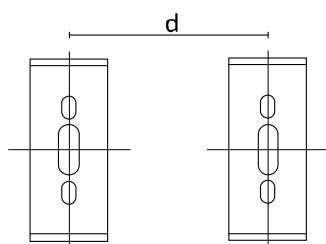

3

