

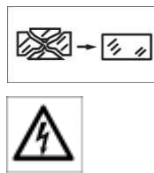

0201

INDUSTRIAL

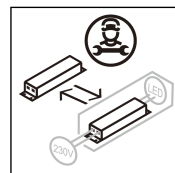
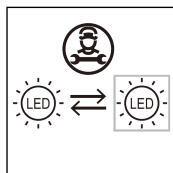

WARNING

ANY MODIFICATION TO THIS FITTING IS FORBIDDEN WITHOUT PRIOR AUTHORIZATION

Our policy is the constant improvement of the product. We reserve the right to modify the characteristics of the equipment without prior notice. Please refer to the website www.arcluce.it for this and other technical documents continually updated.

All information is presented in good faith. no responsibility may be imputed to us for errors, omissions or incorrect interpretations.

The photographs and drawings are within the limits of the quality of the printed reproduction, not binding and indicative only.

Directive 2002/96/CE (Waste Electrical and Electronic Equipment - WEEE). The crossed out wheeled bin label indicates that this product should not be disposed how the normal household waste stream, but with a separate collection; this in order to prevent potential negative consequences for the environment and the human health. For more details on available collection facilities please contact your local government office or the dealer where you purchased this product.

The safety and the proper functioning of the fitting is guaranteed only respecting the electrical Standards and this mounting instructions; therefore it's necessary to keep them.

Installation should be carried out by a suitable qualified person. Always refer to electrical data on the fixture label.

The light source contained in this luminaire shall only be replaced by the manufacturer or his service agent or a similar qualified person. Only use original ARCLUCE spare parts.



Turn off power before maintenance.

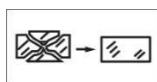

Replace any cracked shield.



Risk group 1 (IEC/TR62778). Do not stare at operating LED. The luminaire should be positioned so that prolonged staring into the luminaire at a distance closer than 2 m is not expected.

SPECIFICATIONS

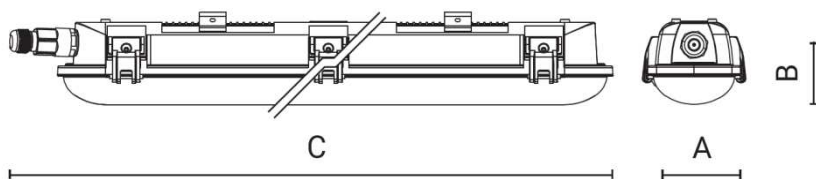

MECHANICAL

Dimensions:	A: 104 mm B: 87mm C: 650 / 1220 / 1560 mm
Weight:	1 / 1.8 / 2.2 Kg
Rated Ta (max Ta):	-20°C + +25°C (45°C)

ELECTRICAL

Wiring:	ON/OFF
Input:	220-240V 50/60Hz

INSTALLATION

1. Install brackets on the supporting surface respecting correct spacing, using appropriate screws and dowels (by others).
2. Wire the fixture according to diagram.

1



Turn off power (1).

FIXTURE LENGTH **D**

650 mm 350

1220 mm 860

1560 mm 1200

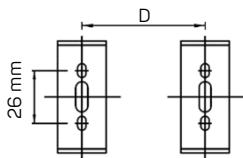

CEILING



Use only screws and dowels suitable for the mounting surface (by others) (2).

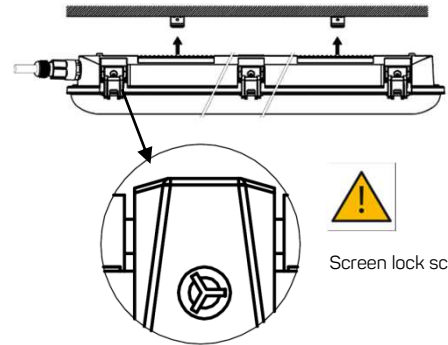
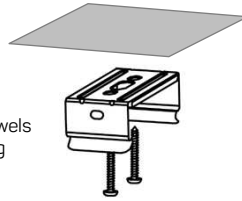

Screen lock screw (3).

SUSPENSION

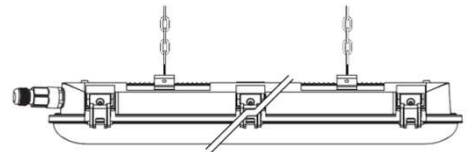
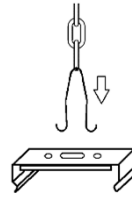
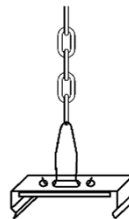
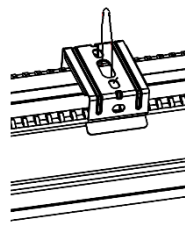

2

A



Slide cable through cable gland (1).

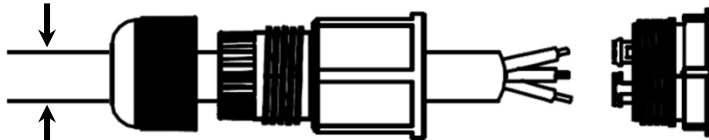

Cable OD: 9 + 11 mm



Connect the wires (2).

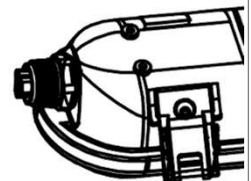
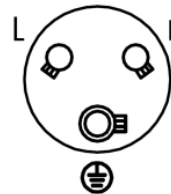

B



Reassemble fast connector (3).

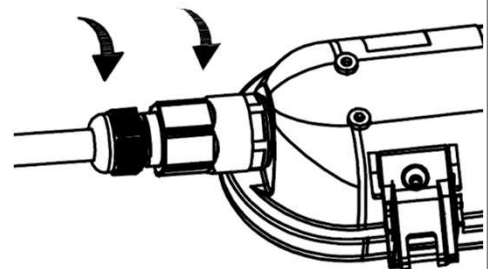
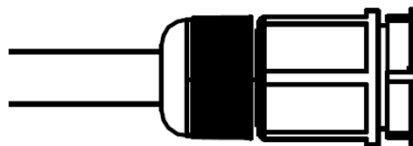

AVERTISSEMENTS

TOUTE MODIFICATION DE CET APPAREIL, SANS AUTORISATION, EST INTERDITE

Notre politique est l'amélioration constante du produit. Nous nous réservons le droit de modifier les caractéristiques de l'équipement sans préavis. Veuillez-vous référer au site web www.arcluce.it pour cela et d'autres documents techniques continuellement mis à jour. Toutes les informations sont présentées de bonne foi, aucune responsabilité ne peut nous être imputée pour des erreurs, des omissions ou des interprétations incorrectes. Les photographies et les dessins sont dans les limites de la qualité de la reproduction imprimée, ils ne sont pas contraignants et à titre indicatif seulement.

Directive 2002/96/CE (Déchets d'Équipements Électriques et Électroniques - DEEE). L'étiquette de la poubelle à roulettes barrée indique que ce produit ne doit pas être éliminé comme les déchets urbains mais par une collecte séparée; ceci afin d'éviter des conséquences négatives potentielles sur l'environnement et la santé humaine.

Pour plus de détails sur les installations de collecte disponibles, veuillez contacter votre administration locale ou le revendeur auprès duquel ce produit a été acheté. La sécurité et le bon fonctionnement du luminaire sont garantis uniquement en respectant les normes électriques et les présentes instructions de montage; donc il est nécessaire de les garder. L'installation doit être effectuée par une personne qualifiée appropriée. Toujours se référer aux données électriques sur l'étiquette du luminaire la source lumineuse contenue dans ce luminaire ne doit être remplacée que par le fabricant, son agent de service ou une personne qualifiée similaire. N'utilisez que des pièces de rechange ARCLUCE.

(1) Avant toute intervention sur l'appareil éteindre l'alimentation. (2) Remplacez les écrans de protection endommagés. (3) Groupe à risque 1 (IEC/TR62778). Le luminaire doit être placé de manière à ne pas provoquer de regards prolongés dans le luminaire à une distance inférieure à 2 m.

INSTALLATION:

1. Installez les étriers sur la surface de support en respectant l'espacement correct, utiliser des vis et des ancrages appropriés (pas fournis).
2. Câblez le luminaire selon le schéma.

IMAGES:

(1.1) Éteindre l'alimentation. (1.2) Utilisez uniquement des vis et des ancrages adaptées à la surface de montage (par d'autres). (1.3) Vis de sécurité. (2.1) Glisser le câble dans le presse-étoupe. (2.2) Connecter les fils. (2.3) Réassembler le connecteur rapide.

AVVERTENZE

SONO VIETATE MODIFICHE ALL'APPARECCHIO SENZA AUTORIZZAZIONE

Perseguiamo una politica di costante miglioramento del prodotto. Ci riserviamo il diritto di modificare le caratteristiche dell'apparecchiatura senza preavviso. Si prega di fare riferimento al sito www.arcluce.it per questo e altri documenti tecnici che vengono continuamente aggiornati. Tutte le informazioni sono presentate in buona fede. Nessuna responsabilità ci può essere attribuita per errori, omissioni o interpretazioni errate. Le fotografie e i disegni sono nei limiti della qualità della riproduzione stampata, non sono vincolanti e solo per informazione.

Direttiva 2002/96/CE (Rifiuti di Apparecchiature Elettriche ed Elettroniche - RAEE). Il pittogramma del bidone con ruote barrato indica che questo prodotto non deve essere smaltito come normale rifiuto urbano ma attraverso raccolta separata; questo per evitare potenziali conseguenze negative per l'ambiente e la salute umana. Per i dettagli sulle strutture di raccolta disponibili, contattare l'ufficio governativo locale o il rivenditore presso il quale è stato acquistato il prodotto.

La sicurezza e il corretto funzionamento dell'apparecchio sono garantiti solo rispettando le normative elettriche e queste istruzioni pertanto è necessario conservarle.

L'installazione deve essere eseguita da personale qualificato fare sempre riferimento ai dati elettrici presenti sull'etichetta dell'apparecchio. La sorgente luminosa contenuta in questo apparecchio deve essere sostituita solo dal costruttore o dal suo servizio di assistenza o da personale altrettanto qualificato. Utilizzare solamente pezzi di ricambio originali ARCLUCE.

(1) Prima di qualsiasi intervento sul dispositivo, spegnere l'alimentazione. (2) Sostituire gli schermi di protezione danneggiati. (3) Gruppo di rischio 1 (IEC/TR62778). L'apparecchio deve essere posizionato in modo da non causare sguardi prolungati nell'apparecchio a una distanza inferiore a 2m.

INSTALLAZIONE

(1) Installare le staffe sulla superficie di supporto rispettando la distanza corretta, utilizzare viti e tasselli appropriati (non forniti). (2) Collegare l'apparecchio secondo lo schema
(3) Fissare l'apparecchio al supporto.

IMMAGINI

(1.1) Spegner l'alimentazione. (1.2) Utilizzare solo viti e tasselli adatti alla superficie di montaggio (non forniti). (1.3) Vite di sicurezza. (2.1) Far scorrere il cavo nel pressacavo. (2.2) Collegare i fili. (2.3) Rimontare il connettore rapido.